

ITL Part Code - EL50K

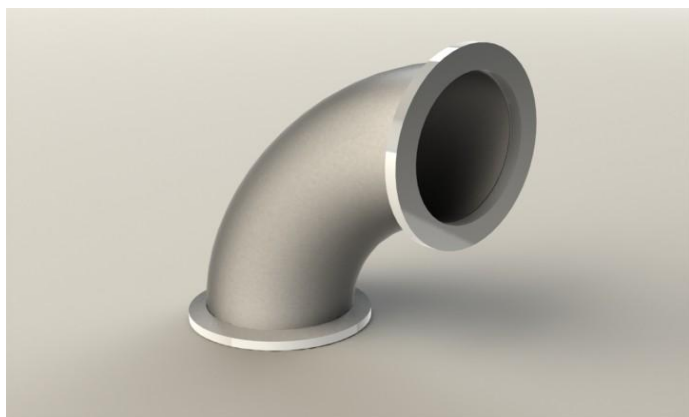

Specification

Material: 304L Stainless Steel

A	D1	R
70 (2.76)	57.0 (2.24)	65 (2.56)

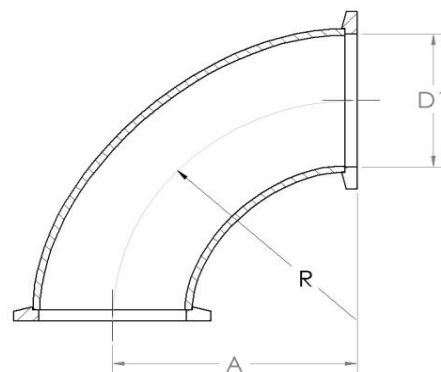

Specialist UK manufacturers and suppliers of standard and bespoke vacuum products.
For all enquiries please contact us on: